

# VYSOCE VÝKONNÉ OTĚRUVZDORNÉ DÍLY

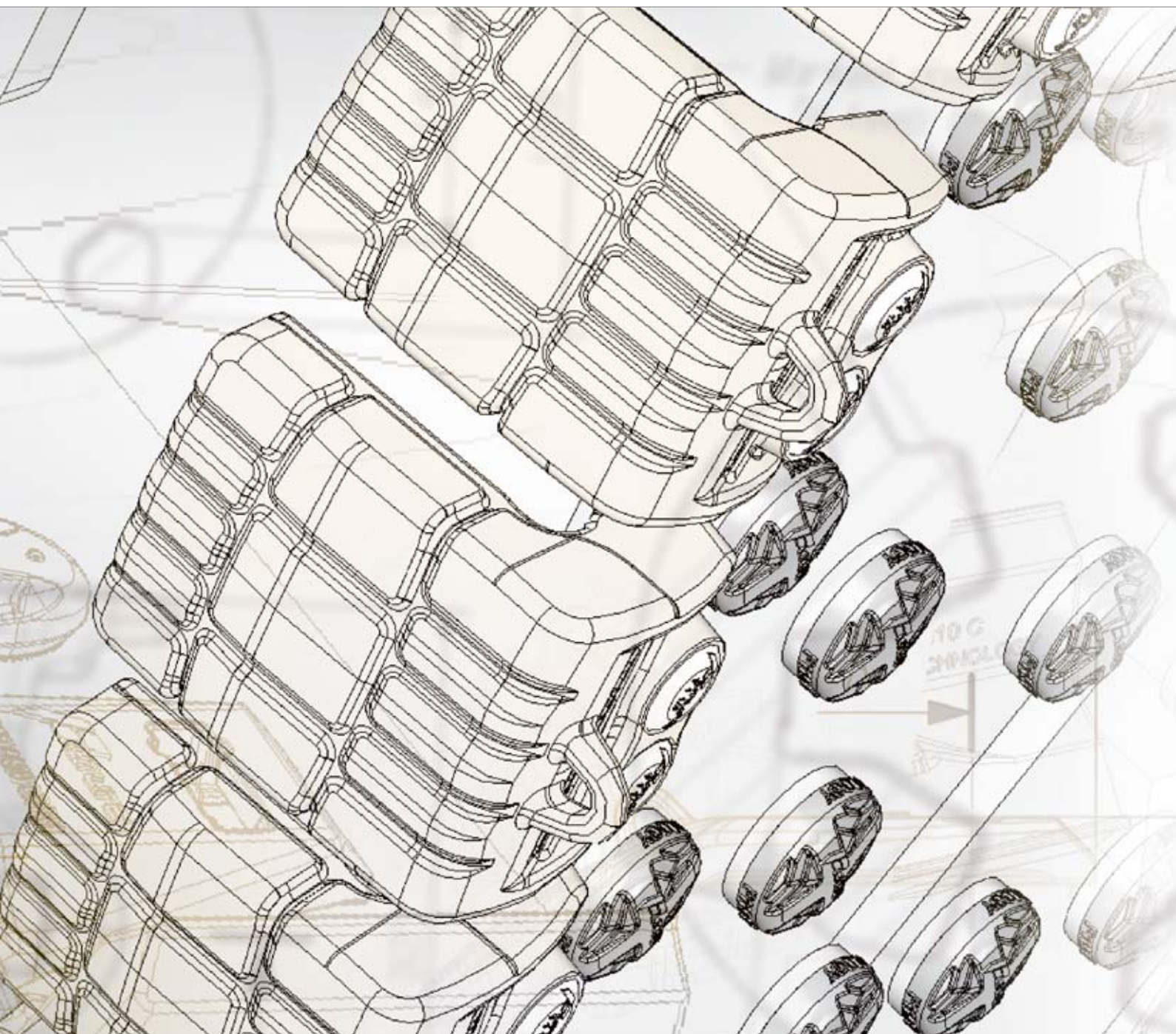

 **utura**  
wear **technology**

## FUTURA zub oproti STANDARDNÍMU zubu

Extra přidaný materiál na zesilujícím bočním žebrou a ochrana čepu ✓

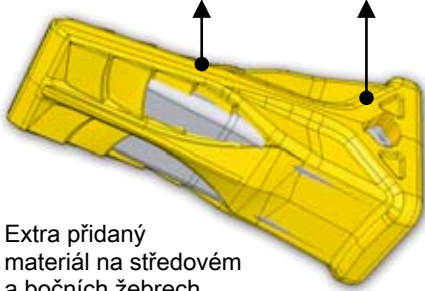

Extra přidaný materiál na středovém a bočních žebrech zajišťuje samo brousící efekt ✓

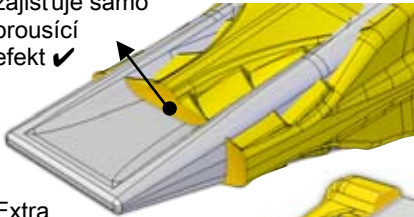

Extra materiál na špičce zubu a centrálním žebrou ✓

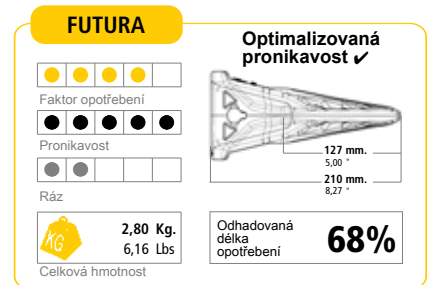
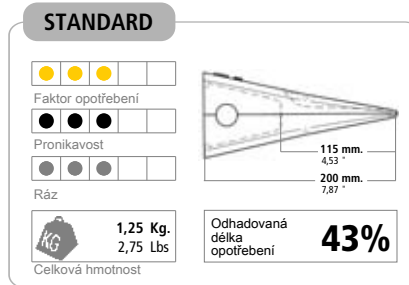
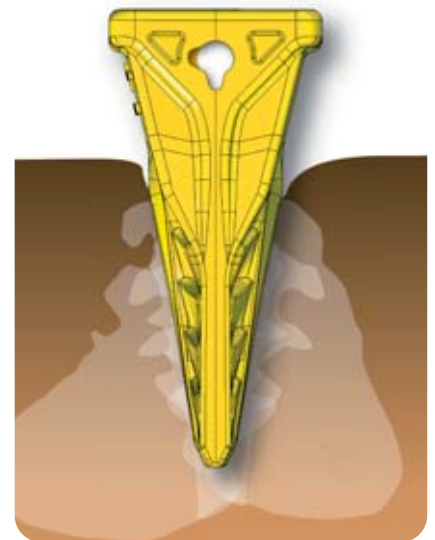
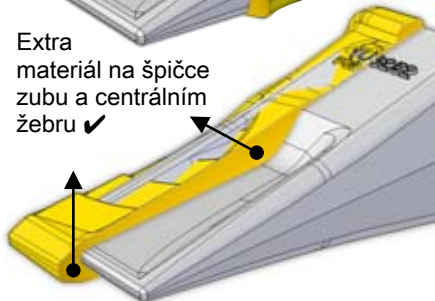

### Osvědčený výkon

Vystupující centrální žebro, postranní žebra a vybrání napomáhají toku materiálu, výrazně prodlužují životnost, zlepšují ostrost a vlastnosti, které poskytují lepší pronikavost zubu, zachovávají ostrost bez snížení pevnosti.

Více než 89% oceli použité na výrobky FUTURA je účelně využito, než je nutná výměna zubu.

**Díky svému optimalizovanému tvaru ani po opotřebení 89% materiálu zub neztrácí ostrost ✓**

FUTURA zuby jsou všeobecně těžší než jiné konkurenční zuby stejné kategorie, velikosti a modelu. Váha byla přidána v klíčových oblastech, kde zub podléhá opotřebení ✓

FUTURA ŘADA má přibližně o 20% více použitelného opotřebitelného materiálu než jiné obdobné systémy na trhu.

Nejedná se pouze o větší délku zubu nebo procentuální zvýšení celkové hrubé hmotnosti. Důležitá je skutečně využitelná celková čistá hmotnost opotřebitelného materiálu, která znamená méně výměn zubů v provozu.

**FUTURA zuby po mnoha pracovních cyklech ✓**

Přidali jsme sice materiál na dno a po stranách těla zubů ale přitom jsme zvýšili i pronikavost a zlepšili kopací vlastnosti.

### Samo ostřící tvar

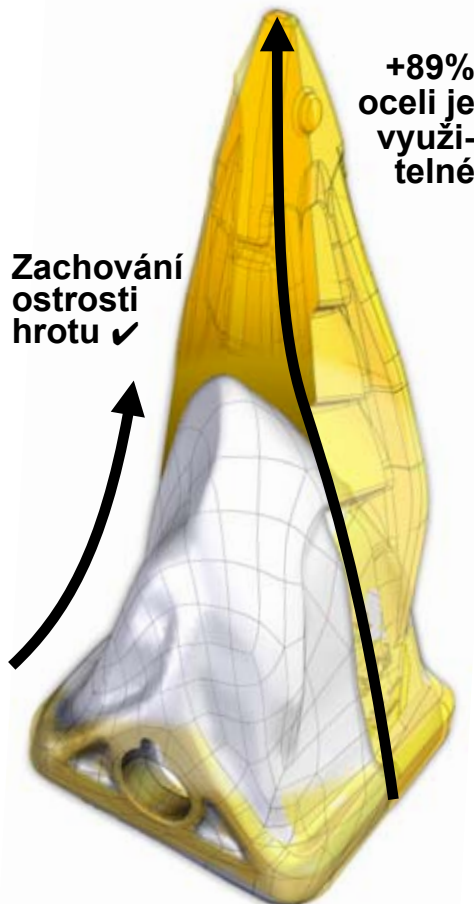

### Konkurenceschopná cena





**Promyšlená otěruvzdorná technologie za dostupnou cenu**

Index	
FUTURA TWISTER	3
TWISTER HAMMERLESS	3
FUTURA MINING	6
FUTURA CLACK	9
FUTURA II	10
DRP for	
Caterpillar	9
Esco	12
Fiat-Hitachi	12
Komatsu	12
Mini Excavator	12
FUTURA RIPPER	13
FUTURA BUCKET	14

Malá stavební	Stavební	Velká stavební	Těžební
---------------	----------	----------------	---------

Průvodce k určení velikosti dle maximální hmotnosti stroje (t)

		130	170	190	230	290	330	390	430	510	590	610	690	710	810
	Standard	5,9	8,7	11,5	16,7	25,0	33,8	46,9	63,6	81,2	103,7	144,1	248,4	345,1	
	HD	4,5	6,8	8,9	12,9	19,5	25,0	33,4	46,9	63,6	81,2	103,7	136,4	211,3	
	ST/HD	4,4	7,1	10,0	15,7	21,7	29,4	39,9	53,3	67,4	88,8	119,9	188,0	270,5	402,2
	Extra HD	3,4	5,4	7,6	12,0	16,3	22,1	30,2	39,9	53,3	67,4	88,8	129,9	188,0	275,2
	ST/HD									62,2	82,9	110,0	161,1	218,5	334,5
	Extra HD									48,6	62,2	82,9	120,4	161,1	231,9

Pro použití pouze s TWISTER pojistkou



## Futura TWISTER je záměnný se zuby a adaptéry Esco Super V®



FUTURA TWISTER zuby je možno použít i na vaše stávající adaptéry typu HELIX ✓



FUTURA TWISTER čepy a adaptéry jsou použitelné i s vašimi stávajícími HELIX zuby ✓

Kompletní systém zahrnující zuby, adaptéry a čepy ✓

Velký výběr tvarů pro běžné i náročné aplikace při použití rýpadel a nakladačů. Velikosti od 130 do 810 ✓

TWISTER zuby, adaptéry a čepy jsou záměnné i s jinými díly typu HELIX používanými na trhu ✓



PN-HL RC-HL

Kg	Lb	L	mm	in	Part#	Size
1,4	3	156	6,1"		FT710 PN-HL	710
2,0	4	186	7,3"		FT810 PN-HL	810

Kg	Lb	Part#	Cross Ref	Size
58,7	129	FT710 RC-HL	V71SD	710
91,0	200	FT810 RC-HL	V81SD	810



## TWISTER HAMMERLESS



## ZUBY PRO NAKLADAČE

RPL

Skalní penetrační lehký



Kg	Lb	Part#	Cross Ref.	Size
1,5	3	FT170 RPL	V17TYL SD1 CE	170
2,9	6	FT190 RPL	V19TY SD3 CE	190
4,3	9	FT230 RPL	V23TY SD4 CE	230
6,0	13	FT290 RPL	V29TYL SD5 CE	290

RP

Skalní penetrační



Kg	Lb	Part#	Cross Ref.	Size
10,0	22	FT330 RP	V33AD SD7 SA	330
15,5	34	FT390 RP	V39AD SD8 SA	390
20,2	44	FT430 RP	V43AD SD9 SA	430
27,1	60	FT510 RP	V51AD SD10 SA	510

RPHD

Skalní penetrační HD



Kg	Lb	Part#	Cross Ref.	Size
43,0	95	FT590 RPHD	V59AR	590
46,6	103	FT610 RPHD	V61ARL	610
89,2	196	FT710 RPHD	V71ARL	710

F

Skalní Rozšířený



Kg	Lb	Part#	Cross Ref.	Size
4,6	10	FT230 F	V235F	230
7,0	15	FT290 F	V2956F	290
10,4	23	FT330 F	V3357F	330
14,7	32	FT390 F	V3958F	390
20,2	44	FT430 F	V4359F	430
27,5	61	FT510 F	V51510F	510

## ZUBY PRO RÝPADLA

S

Standardní



Kg	Lb	Part#	Cross Ref.	Size
1,0	2	FT130 S	V13SYL SDM TLR	130
1,5	3	FT170 S	V17TYL SD1 TLR	170
3,3	7	FT190 S	V19SYL SD3 TLR	190
4,3	9	FT230 S	V23SYL SD4 TLR	230
6,2	14	FT290 S	V29SYL SD5 TLR	290
8,0	18	FT330 S	V33SYL SD7 TLR	330
11,8	26	FT390 S	V39SYL SD8 TLR	390
15,9	35	FT430 S	V43SYL SD9 TLR	430
19,9	44	FT510 S	V51SYL SD10 TLR	510
26,3	58	FT590 S	V59SYL SD11 TLR	590
31,5	69	FT610 S	V61SYL	610
40,7	90	FT690 S	V69SYL	690

RC

Skalní dláto



Kg	Lb	Part#	Cross Ref.	Size
8,0	18	FT330 RC	V33SD SD7 PR	330
11,6	26	FT390 RC	V39SD SD8 PR	390
16,1	35	FT430 RC	V43SD SD9 PR	430
21,3	47	FT510 RC	V51SD V51SDX SD10 PR	510
26,2	58	FT590 RC	V59SD V59SDX SD11 PR	590
32,5	72	FT610 RC	V61SD V61SDX SD12 PR	610
46,5	102	FT690 RC	V69SD	690
56,4	124	FT710 RC	V71SD	710
90,3	199	FT810 RC	V81SD	810

I

Rázuvzdorný



Kg	Lb	Part#	Cross Ref.	Size
4,0	9	FT230 I	V23RYL	230
5,7	13	FT290 I	V29RYL	290
7,6	17	FT330 I	V33RYL	330
11,2	25	FT390 I	V39RYL	390
14,6	32	FT430 I	V43RYL	430
19,8	44	FT510 I	V51RYL	510
25,7	57	FT590 I	V59RYL	590
28,1	62	FT610 I	V61RY	610
44,1	97	FT690 I	V69RYL	690
54,2	119	FT710 I	V71RXL V71RYL	710
87,0	191	FT810 I	V81RXL V81RYL	810

TL

Špičatý dlouhý



Kg	Lb	Part#	Cross Ref.	Size
0,8	2	FT130 TL	V13VY SDM PE	130
1,3	3	FT170 TL	V17VY SD1 PE	170
2,5	6	FT190 TL	V19VY SD3 PE	190
3,5	8	FT230 TL	V23VY SD4 PE	230
5,0	11	FT290 TL	V29VY SD5 PE	290
6,9	15	FT330 TL	V33VY SD7 PE	330
9,7	21	FT390 TL	V39VY SD8 PE	390
13,6	30	FT430 TL	V43VY SD9 PE	430

Pro použití pouze s TWISTER pojistkou

VTL

Špičatý dlouhý zesílený



Kg	Lb	Part#	Cross Ref.	Size
17,5	39	FT510 VTL	V51VY V51VYH SD10 PE	510
22,8	50	FT590 VTL	V59VY V59VYH SD11 PE	590
27,8	61	FT610 VTL	V61VX SD12 PE	610
40,3	89	FT690 VTL	V69VX	690
50,7	112	FT710 VTL	V71VX	710
80,0	176	FT810 VTL	V81VX	810

WTL

Dvoj špičatý dlouhý



Kg	Lb	Part#	Cross Ref.	Size
0,9	2	FT130 WTL	V13TVY SDM DPE	130
1,6	3	FT170 WTL	V17TVY SD1 DPE	170
2,9	6	FT190 WTL	V19TVY SD3 DPE	190
4,4	10	FT230 WTL	V23TVY SD4 DPE	230
5,8	13	FT290 WTL	V29TVY SD5 DPE	290
8,3	18	FT330 WTL	V33TVY SD7 DPE	330
11,9	26	FT390 WTL	V39TVY SD8 DPE	390
16,6	37	FT430 WTL	V43TVY SD9 DPE	430
21,4	47	FT510 WTL	V51TVY SD10 PRD	510
26,9	59	FT590 WTL	V59TVY	590
34,7	76	FT610 WTL	V61TVP	610

SYL

Symetrický



Kg	Lb	Part#	Cross Ref.	Size
0,8	2	FT130 SYL	V13SYL	130
1,3	3	FT170 SYL	V17TYL	170
		FT190 SYL	V19SYL	190
		FT230 SYL	V23SYL	230
14,7	32	FT430 SYL	V43SYL	430

PN

Fig A



Fig B

L mm	L inch	Part#	F	Cross Ref.	Size
48	1,9"	FT1317 PN A	A	V13-17PN SDMCL/1CL/2CL	130 170
52	2,0"	FT1923 PN A	A	V23PN SD3CL/SD4CL	190 230
78	3,1"	FT290 PN A	A	V29PN / SD5CL	290
86	3,4"	FT330 PN A	A	V33PN / SD7CL	330
94	3,7"	FT390 PN A	A	V39PN / SD8CL	390
106	4,2"	FT430 PN A	A	V43PN / SD9CL	430
112	4,4"	FT510 PN B	B	V51PN SD10CL/SD11CL	510
121	4,7"	FT590 PN B	B	V59PN SD10CL/SD11CL	590
131	5,1"	FT610 PN B	B	V61PN / SD12CL	610
146	5,7"	FT690 PN B	B	V69PN	690
160	6,3"	FT710 PN B	B	V71PN	710
187	7,4"	FT810 PN B	B	V81PN	810

Klíč k označení dílů

Značka	Typ	Velikost	Verze	Rock	Penetration	Light
F	T	330	R	P	L	

## TWISTER ČEPY

FUTURA TWISTER čepy mohou být použity několikrát ✓

Čepy FUTURA TWISTER jsou navrženy tak že je možné použití i s jinými HELIX výrobky na trhu ✓

## TWISTER ADAPTERY PRO NAKLADAČE

**BOC**

Šroubované  
a boční  
adaptery



Kg	Lb	N°	B°	↓	↘	Part#	Cross Ref.	Size	
11	24	25	1,0"	30	1,2"	FT230-25 BOC23	5788L-V23 5788R-V23	230	
7	15	30	1,2"	-	-	FT230-30 BOC19	5774A-V23		
12	26	35	1,4"	-	-	FT290-35 BOC23	3767-V29	290	
14	31	25	40	1,6"	26	1,0"	FT290-40 BOC23	5773-V29	
16	35	40	1,6"	26	1,0"	FT330-40 BOC23	5773-V33	330	

**BO**

Šroubované  
adapt.  
pro  
nakladače



Kg	Lb	N°	B°	↓	↘	Part#	Cross Ref.	Size
5,0	11	15	20	0,8"		FT190-20 BO16	5775-V19	190
5,1	11	15	25	1,0"		FT190-25 BO16	5776-V19	
7,6	17	15	25	1,0"		FT230-25 BO16	3868A-V23	
6,6	15	15	25	30	1,2"	FT230-30 BO16	5734A-V23	230
8,2	18	15	35	1,4"		FT230-35 BO16	5734A-V23	
9,4	21	15	35	1,4"		FT290-35 BO16	3766A-V29	290
10,9	24	15	25	40	1,6"	FT290-40 BO16	8719-V29	
12,0	26	15	40	1,6"		FT330-40 BO16	8719-V33	330

**FL**

Shora  
vařené  
adaptery



Kg	Lb	N°	B°	↓	↘	Part#	Cross Ref.	Size
1,3	3	15	22	16	0,8"	FT130 FL	8843-V13	130
2,4	5	15	22	20	0,8"	FT170 FL	8806-V17	170
4,5	10	15	22	20	0,8"	FT190 FL	8806-V19 8802-V19	190
7,0	15	15	22	30	1,2"	FT230 FL	8803-V23 8830-V23	230
10,0	22	15	22	35	1,4"	FT290 FL	8831-V29 3829A-V29	290
13,2	29	15	22	40	1,6"	FT330 FL	8831-V33 3892-V33	330
26,1	57	15	30	63,5	2,5"	FT430 FL	8837-V43 1852-V43	430

## TWISTER ADAPTERY

**X**

Adaptery  
pro rýpadla



Kg	Lb	N°	B°	↓	↘	Part#	Cross Ref.	RH	LH	Size
1,2	2,6	15	30	16	0,6"	FT130	1610T-V13	✓	✓	130
2,0	4,3	15	30	20	0,8"	FT170	8841-V17	✓	✓	170
2,5	5,5	15	23	25	1,0"	FT170-25	8842-V17	✓	✓	
4,8	10,6	15	30	25	1,0"	FT190	8822-V19 5854-V19	✓	✓	190
6,8	15,0	15	30	25	1,0"	FT230	5854-V23	✓	✓	
6,5	14,3	15	30	30	1,2"	FT230-30	3880-V23 5849-V23	✓	✓	230
8,4	18,5	10	30	30	1,2"	FT290	5849-V29	✓	✓	
7,8	17,2	10	30	35	1,4"	FT290-35	3881A-V29 3871A-V29	✓	✓	290
7,8	17,2	10	30	40	1,6"	FT290-40	3882A-V29 5850-V29	✓	✓	
11,4	25,1	10	30	40	1,6"	FT330	5855-V33 3882A-V33 SD7 1540	✓	✓	330
16,3	35,9	10	30	45	1,8"	FT390	3810A-V39 SD8 1545	✓	✓	390
23,2	51,0	10	30	50	2,0"	FT430	8801-V43 5856-V43 SD9 1550	✓	✓	430
28	61	10	30	60	2,4"	FT510	5857A-V51 3811-V51		FT510 C	510
38	83	10	30	70	2,8"	FT590	3858-V59		FT590 C	590
60	132	10	30	80	3,1"	FT610	5898-V61		FT610 C or FT610 CST	610
74	162	10	30	80	3,1"	FT690	5898-V69		FT690 C or FT690 CST	690
75	164	10	30	90	3,5"	FT690-90	6803-V69		FT690 C or FT690 CST	
122	267	10	30	90	3,5"	FT710	2837-V71		FT710 C or FT710-100 CST	710
118	260	10	30	100	3,9"	FT710-100	5897-V71		FT710 C or FT710-100 CST	
177	390	10	30	120	4,7"	FT810	3869B-V81		FT810 C or FT810 CST	810
200	440	10	30	140	5,5"	FT810-140	6806-V81		FT810 C or FT810-140 CST	

**LH**

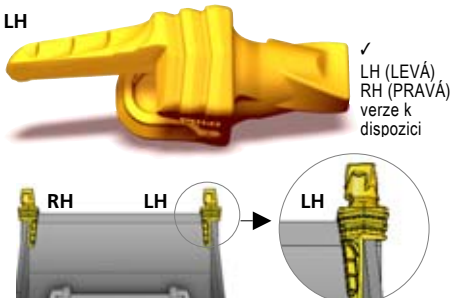

✓  
LH (LEVÁ)  
RH (PRAVÁ)  
verze k  
dispozici

## TWISTER ADAPTERY

**BL**

Univerzální  
adaptery



Kg	Lb	N°	B°	↓	↘	Part#	Cross Ref.	Size
1,0	2	17	30	15	0,6"	FT130 BL	833-V13	130
2,2	5	17	30	20	0,8"	FT170 BL	833-V17	170
3,5	8	17	30	25-30	1"-1,2"	FT190 BL	833-V19	190
4,8	11	15	30	30	1,2"	FT230 BL	3870-V23	230

## NAVAŘOVACÍ NOS

**WN**

Navařovací nos je  
nejsnazší a nejrych-  
lejší cesta na záměnu  
stávajícího  
držáku zubu na  
vysoce výkonný  
TWISTER  
systém ✓



Kg	Lb	Part#	Cross Ref.	Size
0,50	1,10	FT130 WN		130
0,90	1,98	FT170 WN		170
1,80	3,96	FT190 WN	WN-V19	190
2,70	5,94	FT230 WN	WN-V23	230
3,70	8,14	FT290 WN	WN-V29	290
5,20	11,44	FT330 WN	WN-V33	330
7,20	15,84	FT390 WN	WN-V39	390
10,10	22,22	FT430 WN	WN-V43	430
14,95	32,89	FT510 WN	WN-V51	510
19,00	41,80	FT590 WN	WN-V59	590
23,50	51,70	FT610 WN	WN-V61	610
33,80	74,36	FT690 WN	WN-V69	690
47,50	104,50	FT710 WN	WN-V71	710
84,20	185,24	FT810 WN	WN-V81	810

## DEMONTÁŽNÍ NÁSTROJ

**EXTFT-1333**

Velikosti 130 až 330

**EXTFT-3961**

Velikosti 390 až 610

**EXTFT-6981**

Velikosti 690 až 810



## ZESÍLENÉ LITÉ BOČNÍ ADAPTERY

**C**

Boční



Kg	Lb	N°	B°	↓	↘	Part#	Cross Ref.	Size
94	207	70	2,8"	50	2,0"	FT510 C	-	510
107	235	70	2,8"	50	2,0"	FT590 C	-	590
152	334	90	3,5"	75	3,0"	FT610 C	RC-V61 R/L CR-V61 LA/RA	610
179	394	90	3,5"	75	3,0"	FT690 C	RS-V69 R-V69 L/R	690
282	620	100	3,9"	75	3,0"	FT710 C	RS-V71 R-V71 L/R	710
431	948	140	5,5"	90	3,5"	FT810 C	6807-V81 R-V81 R1/L1	810



**CST**

Boční s  
výřezem



Kg	Lb	N°	B°	↓	↘	Part#	Cross Ref.	Size
87	191	80	3,1"	50	2,0"	FT610 CST	6822-V61	610
114	251	90	3,5"	70	2,8"	FT690 CST	6824-V69	690
147	322	100	3,9"	80	3,1"	FT710-100 CST	5899-V71	710
210	462	120	4,7"	90	3,5"	FT810 CST	5895L-V81 5895R-V81	810
218	479	140	5,5"	90	3,5"	FT810-140 CST	6808L-V81 6808R-V81	





## FUTURA MINING pro stroje až do 800 tun.



Futura Mining zuby použitelné na ESCO® Standardní Posilok® stejně jako Posilok® Plus střední adaptér.



Futura Mining středové adaptéry lze nasadit na adaptér Esco® Posilok®.



Esco® Posilok® a Posilok® Plus zuby lze použít na Futura Mining středové adaptéry.



### RYCHLÝ PRŮVODCE VÝBĚREM

Středový adapter	950	1100	1300	1450
Zub	920	920	1120	1220
Hmotnost stroje	< 350T	350-500T	500-750T	750-1000T
HITACHI	EX3500, EX3500-3	EX3600	EX5500, EX5600	EX8000
TEREX	RH120E	RH170	RH340 RH360	RH400
CATERPILLAR	6030, 5230ME, 3560B	6040 5230B	6060	6090FS
KOMATSU	PC3000, PC3000-6	PC4000	PC4000, PC5500 PC5500-6	PC8000
KOMATSU (DEMAG)	H285	H285S	H485S	H48JS
LIEBHERR	R994 R9250	R9400 R9350 R994B	R995	R9800 R996

### FUTURA MINING VELIKOST 950

RC

Dlouhý



Kg	Lb	Part#	Cross Ref.	Size
106,8	235	FM950 RC	fits S95SD	950

I

Rázuvzdorný



Kg	Lb	Part#	Cross Ref.	Size
104,6	230	FM950 I	fits S95RS	950

PNK

Čep pojistný



L mm	inch	Ø inch	Kg	Lb	Part#	Cross Ref.	Size
280	11,0	61	2,4	5,2	11,3	FM950 PNK	S95RPN 950

## FUTURA MINING ZUBY A STŘEDOVÉ ADAPTERY

RC

Skalní dláto



Kg	Lb	Part#	Cross Ref.	Cross Ref.	Nose	Adapt
61	133	<b>FM920 RC</b>	DRP 92KHA	DRP 92TKHA	920	<b>1100</b>
76	167	<b>FM1120 RC</b>	DRP 112KH	DRP 112TKH	1120	<b>1300</b>
105	231	<b>FM1220 RC</b>	DRP 122KH	DRP 122TKH	1220	<b>1450</b>

RCXL

Skalní dláto XL



Kg	Lb	Part#	Cross Ref.	Cross Ref.	Nose	Adapt
99	218	<b>FM1120 RCXL</b>	DRP 112KHRML	DRP 112TKHRML	1120	<b>1300</b>
134	295	<b>FM1220 RCXL</b>	DRP 122KHM	DRP 122TKRXL	1220	<b>1450</b>

WT

Dvoj špičatý dlouhý



NOVÝ

Kg	Lb	Part#	Cross Ref.	Cross Ref.	Nose	Adapt
		<b>FM920 WT</b>	DRP 92KTVP	DRP 92TKTVP	920	<b>1100</b>
76,0	167	<b>FM1120 WT</b>	DRP 112KTVL	DRP 112TKTL	1120	<b>1300</b>
94,0	207	<b>FM1220 WT</b>	DRP 122KTV	DRP 122TKTV	1220	<b>1450</b>

## SESTAVY VELIKOSTÍ 1100 1300 1450

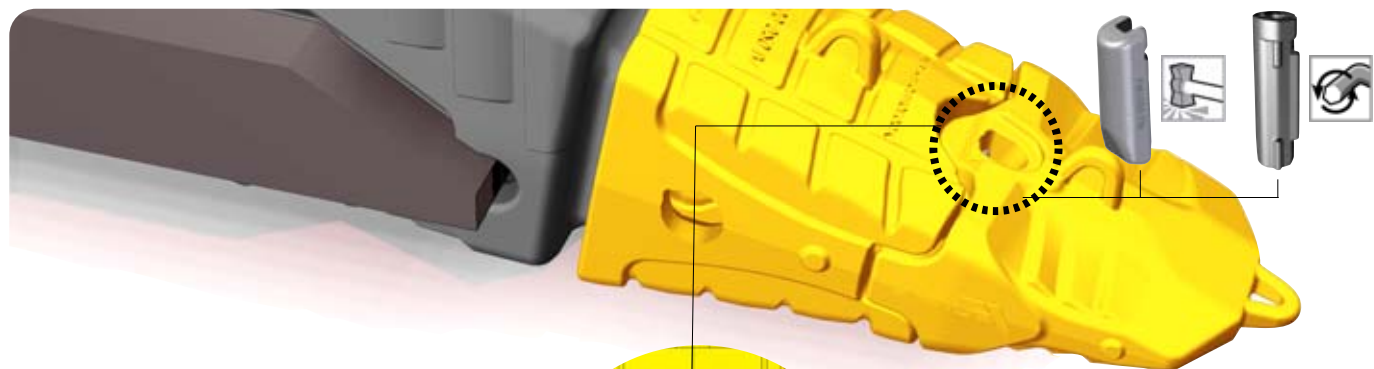

PN

**STANDARDNÍ MINING POJISTKA**



Pro montáž Posilok® a Posilok® Plus

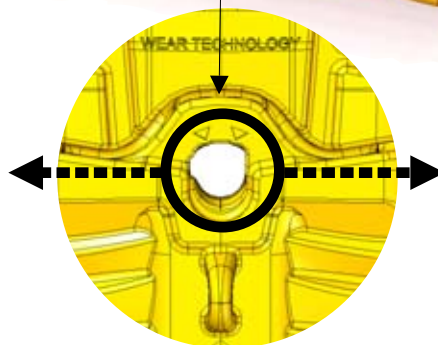

**2 POJISTKY NA VÝBĚR: STANDARD NEBO BEZ POUŽITÍ KLAĐIVA**

**Maximální kompatibilita**  
Jeden zub pro dva systémy: Montáž S i BEZ použití KLAĐIVA.  
Vhodný na Posilok® STANDARD a Posilok® PLUS středové adaptéry.

Lmm	in	Ø	in	Kg	Lb	Part#	Cross Ref	Nose	Size
147	5,8	38	1,5	1,2	2,6	<b>FM920 PN</b>	DRP PN92K	920	<b>1100</b>
158	6,2	44	1,7	1,6	3,5	<b>FM1120 PN</b>	DRP PN112KC	1120	<b>1300</b>
189	7,4	50	2,0	2,3	5,0	<b>FM1220 PN</b>	DRP PN122KC	1220	<b>1450</b>

HL

**FUTURA MINING POJISTKA BEZ POUŽITÍ KLAĐIVA**



Pasuje na Posilok® Plus

Lmm	in	Ø	in	Kg	Lb	Part#	Cross Ref	Nose	Size
147	5,8	38	1,5	1,5	3,4	<b>FM920 HLK</b>	92TK PN	920	<b>1100</b>
158	6,2	44	1,7	1,8	4,0	<b>FM1120 HLK</b>	112TKPN-B	1120	<b>1300</b>
						<b>FM1220 HLK</b>	122TKPN	1220	<b>1450</b>

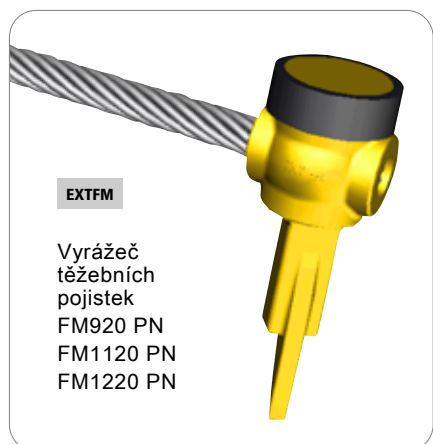

EXTFM

Vyrázeč těžebních pojistek FM920 PN FM1120 PN FM1220 PN

IA

Adapter



Kg	Lb	Part#	Cross Ref.	Cross Ref.	Nose	Adapt
134	295	<b>FM1100-920 IA</b>	S110H92K	S110H92TK	920	<b>1100</b>
192	423	<b>FM1300-1120 IA</b>	S130H112K	S130H112TK	1120	<b>1300</b>
		<b>FM1450-1220 IA</b>	S145H122K	S145H122TK	1220	<b>1450</b>
		<b>FM1600-1220 IA</b>	S160H122K	S160H122TK	1600	<b>1600</b>

PIAK

Čep středového adaptéru

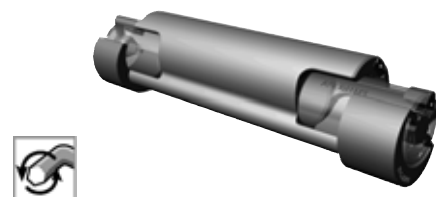

Lmm	in	Ø	in	Kg	Lb	Part#	Cross Ref	Adapt
327	12,9	62	2,4	5,3	11,7	<b>FM1100 PIAK</b>	S110PN	<b>1100</b>
378	14,9	61	2,4	8,0	17,6	<b>FM1300 PIAK</b>	S130PNA	<b>1300</b>
						<b>FM1450 PIAK</b>	S145PNA	<b>1450</b>
								<b>1600</b>

## KRYT BŘITU

LS

Výměnný kryt břitu

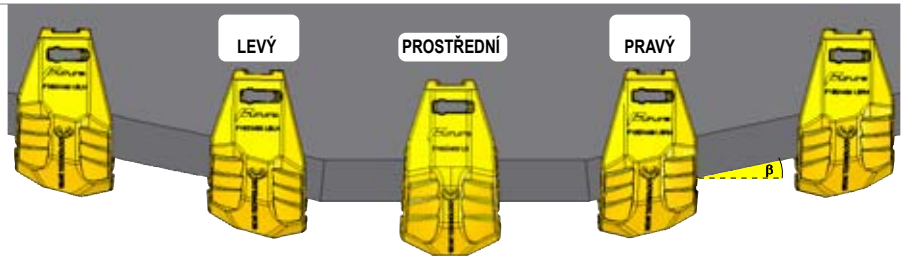

LSLH

LS

LSRH

Kg	Lb	LH	Cross Ref	$\beta^\circ$	Part#	Cross Ref	RH	Cross Ref	Base+Pin	
45	98	90 3,5"	F90X245 LSLH	TAC90X245-2LA	14	F90X245 LS	TAC90X245-1A	F90X245 LSRH	TAC90X245-2RA	FAB FAP
79	173	90 3,5"	F90X320 LSLH	TAC90X320-6L	14	F90X320 LS	TAC90X320-5	F90X320 LSRH	TAC90X320-6R	
85	187	100 3,9"	F100X290 LSLH	TBC100X290-4L	14	F100X290 LS	TBC100X290-3	F100X290 LSRH	TBC100X290-4R	
88	194	100 3,9"	F100X320 LSLH	TBC100X320-2LA	14	F100X320 LS	TBC100X320-1B	F100X320 LSRH	TBC100X320-2RA	
126	278	100 3,9"	F100X410 LSLH	TBC100X410-4L	14	F100X410 LS	TBC100X410-3	F100X410 LSRH	TBC100X410-4R	
133	293	100 3,9"	F100X430 LSLH	TBC100X430-2L	14	F100X430 LS	TBC100X430-1	F100X430 LSRH	TBC100X430-2R	
120	264	120 4,72"	F120X330 LSLH	TBC120X330-2LA	14	F120X330 LS	TBC120X330-1A	F120X330 LSRH	TBC120X330-2RA	FBB FBP
154	338	120 4,72"	F120X410 LSLH	TBC120X410-3L	14	F120X410 LS	TBC120X410-4	F120X410 LSRH	TBC120X410-3R	
127	279	120 4,72"	F120X440 LSLH	TBC120X440-2LB	11,5	F120X440 LS	TBC120X440-1B	F120X440 LSRH	TBC120X440-2RB	
174	382	140 5,5"	F140X420 KLSLH	TBC140X420-2LA	11,5	F140X420 KLS	TBC140X420-1A	F140X420 KLSRH	TBC140X420-2RA	
236	519	160 6,3"	F160X450 KLSLH	TBC160X450-2L	14	F160X450 KLS	TBC160X450-1	F160X450 KLSRH	TBC160X450-2R	
360	792	230 9,0"				F230X430 KLS	TCCF130-28 TCCF130-21B TCCF130-21C TCCF130-16A			FCB FCP

KRYT ZÁKLADNA POJISTKA



SESTAVA VÝMĚNNÉHO KRYTU BŘITU

## FUTURA MINING KRYTY BŘITU: ZÁKLADNY A POJISTKY

PIN

Pojistka krytu břitu



Kg	Lb	Part#	Cross Ref
0,9	2,0	FAP	TAP
2,2	4,8	FBP	TBP
7,6	16,7	FCP	TCP

BASE

Základna krytu břitu



Kg	Lb	Part#	Cross Ref
0,8	1,8	FAB	TAB
1,9	4,1	FBB	TBB
3,9	8,5	FCB	TCB

EXTFL

Páčidlo pojistky krytu břitu



FE

Kryt břitu k navaření



Kg	Lb	Part#	Cross Ref
34,6	76	FEB90	B90
36,4	80	FEB90 L	B90L
36,0	79	FEB90 R	B90R
42,0	92	F120 LS	CESA 24 26-2A
41,9	92	F120 LSRH	CESA 24 26-2A/RA
41,9	92	F120 LSLH	CESA 24 26-2A/LA

## 2 POJISTKY NA VÝBĚR: STANDARD NEBO BEZ POUŽITÍ KLAĐIVA

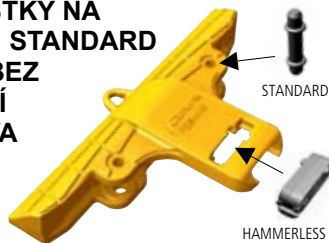

FES

HAMMERLESS

Lmm	in	Kg	Lb	Part#	Cross Ref
796	31,3	50	2,0	59,1	130,1
				FES4410	ES4410

FPDE

STANDARD



HAMMERLESS

Kg	Lb	Lmm	in	Part#	Cross Ref
132	290,4	884	34,8	80	3,1
				FPDE52445	PDE52445

## FUTURA MINING BOČNÍ KRYTY

L	in	Part#	Cross Ref	Base	Pin	BLOCKS	Cross Ref
440	17,3	F40X440 UWS	TAW40X440-1A	FAB	FAP	FDD33095 TB	PDD33095#1
600	23,6	F40X600 UWS	TAW40X600-1	FAB	FAP	FDE51413 TB	PDE51413#3
505	19,9	F50X505 UWS	TAW50X505-2	FAB	FAP	FDD32816 TB	PDD32816#1
505	19,9	F50X505B UWS	TAW50X505-1A	FAB	FAP	FDD32816 TB	PDD32816#1
545	21,5	F75X545 UWS	TBW75X545-1A	FBB	FBP	FDE1987 TBLH	PDE51987#2L
655	25,8	F75X655 UWS	TBW75X655-1	FBB	FBP	FDE1987 TBRH	PDE51987#2R
855	33,7	F90X855 UWS	TBW90X855-1A	FBB	FBP	FDD32678 TB	PDD32678#1
760	29,9	F120X760 UWS	TAW120X760-1	FAB	FAP	FDD33024 TB	PDD33024#1
800	31,5	F140X800 UWS	TBW140X800-1	FBB	FBP	FDD33366 TB	PDD33366#1

## HORNÍ BOČNÍ KRYTY



## SPODNÍ BOČNÍ KRYTY

Part#	Cross Ref	Base	Pin	THRUST BLOCKS	Cross Ref
50	2,0	F50 LWS	TAW50-1	FAB	FAP
65	2,6	F65 LWS	TAW65-1	FAB	FAP
75	3,0	F75 LWS	TAW75-1	FAB	FAP
90	3,5	F90 LWS	TAW90-1	FAB	FAP
115	4,5	F115 LWS	TAW115-1	FAB	FAP
135	5,3	F135 LWS	TAW135-1	FAB	FAP
165	6,5	F165 LWS-RH	TBW165-1R	FBB	FBP
		F165 LWS-LH	TBW165-1L	FBB	FBP

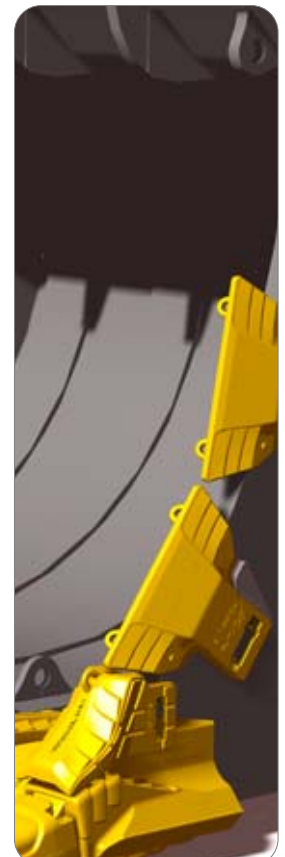





# Futura Clack: universální řešení ovládní pojistky bez kladiva, 100% kompatibilní s vašimi adaptéry typu Caterpillar J

HL2P systém je 100% kompatibilní s Vaším adaptérem se zajištěním čepem z boku ✓

**Zvýšená retence pojistky:** čepy jsou pevně uzamčeny v místě. Gumová vložka pod zámkem umožňuje západce (obr. 3) stlačení, otočení a uzamčení ✓

**Snadná instalace** a vyjmutí klíčkem nebo ráčnou se šestihranem ✓

Každá pojistka je dodávána se zesíleným krytem pro udržení zásuvky v čistotě ✓

Zvýšená bezpečnost ve srovnání s běžným čepem a kroužkem ✓

**100% kompatibilita s OEM adaptéry.** FUTURA systém bez použití kladiva pracuje pouze se zuby FUTURA, ale je plně použitelný na adaptéry typu Caterpillar „J“ ✓



Kryty proti nečistotě jsou součástí každé dodávky dle HL2P objednávacího čísla

## ZUBY PRO NAKLADAČE / RÝPADLA

L						F						SYL					
Dlouhý						Rozšířený						Symetrický					
Kg	Lb	Part#	OEM	Size		Kg	Lb	Part#	OEM	Size		Kg	Lb	Part#	OEM	Size	
1,6	4	FC200 L	1U-3202	20		1,5	3	FC200 F	109-9200	20		2,0	4	FC200 SYL	1U-3202 SYL	20	
2,1	5	FC220 L	6Y-3222	22		3,9	9	FC250 F	3G-8250	25		4,1	9	FC250 SYL	1U-3252 SYL	25	
3,4	7	FC250 L	1U-3252	25		6,8	15	FC300 F	4T-1300 107-3300	30		5,8	13	FC300 SYL	1U-3302 SYL 183-5300	30	
4,5	10	FC300 L	1U-3302	30		9,3	20	FC350 F	8J-3350 107-3350	35		8,0	18	FC350 SYL	1U-3352 SYL 168-1359	35	
7,1	16	FC350 L	1U-3352	35		12,8	28	FC400 F	7T-3400 107-3400	40		15,4	34	FC400 SYL	8E-4402 SYL 168-1409	40	
8,6	19	FC400 L	7T-3402	40		18,5	41	FC450 F	8J-1450 107-3450	45		17,0	37	FC450 SYL	9W-8452 SYL 159-0459	45	
13,3	29	FC450 L	9W-8452	45		28,8	63	FC550 F	7J-9550 107-3550	55		26,5	58	FC550 SYL	9W-8552 SYL 159-0559	55	
20,6	45	FC550 L	9W-8552	55								40,6	89	FC600 SYL	159-0607	60	
31,0	68	FC600 L	6I-6602	60													

Part#	OEM pins	OEM retain	Size
FC300HL2P	107-3308	8E-6259	30
	132-4766	3G-9609	
	9J-2308	149-5733	
FC350HL2P	8E-6358	8E-6359	35
	114-0358	3G-9548	
	9J-2358	114-0359	
FC400HL2P	7T-3408	8E-8409	40
	116-7408	116-7409	
FC450HL2P	8E-0468	8E-8469	45
	114-0468	107-3469	
FC550HL2P	6Y-8558	8E-5559	55
	107-3378	3G-9559	
	1U-1558	107-8559	
FC600HL2P	6I-6608/	6I-6609	60
	113-9608	113-9609	
FC700HL2P	4T-4708	4T-4707	70
	113-4708	113-4709	
FC800HL2P	134-1808	101-2874	80
	102-0101	134-1809	

## ZUBY PRO NAKLADAČE TYP CATERPILLAR

RPL						RP						RPHD						RPHD2					
Skalní penetrační lehký						Skalní penetrační						Skalní penetrační zesílený HD						Skalní penetrační s výměnnou botkou					
Kg	Lb	Part#	OEM	Size		Kg	Lb	Part#	OEM	Size		Kg	Lb	Part#	OEM	Size		Kg	Lb	Part#	OEM	Size	
1,9	4	FC200 RPL	4T-2203	20		5,9	13	FC250 RP	4T-2253 RP	25		19,3	42	FC400 RPHD	135-9400	40		27,1	60	FC450 RPHD2	138-6451	45	
3,8	8	FC250 RPL	9N-4252	25		8,4	18	FC300 RP	4T-2303 RP	30		27,9	61	FC450 RPHD	138-6451	45		32,2	71	FC550 RPHD2	138-6552	55	
6,0	13	FC300 RPL	9N-4302	30		11,7	26	FC350 RP	4T-2353 RP	35		33,4	73	FC550 RPHD	138-6552	55		56,5	124	FC600 RPHD2	135-9600	60	
8,5	19	FC350 RPL	9N-4352	35		16,1	35	FC400 RP	7T-3403 RP	40		60,5	133	FC600 RPHD	135-9600	60		74,5	164	FC700 RPHD2	135-9700	70	
11,5	25	FC400 RPL	8E-4402	40		24,0	53	FC450 RP	9W-1453 RP	45		74,1	163	FC700 RPHD	135-9700	70		123,2	271	FC800 RPHD2	135-9800	80	
17,9	39	FC450 RPL	9N-4452	45		29,0	64	FC550 RP	9W-1553 RP 6Y-2553	55		120,5	265	FC800 RPHD	135-9800	80							
22,0	48	FC550 RPL	9N-4552	55		51,7	114	FC600 RP	6I-6603 RP	60													
38,8	85	FC600 RPL	7Y-0602	60		65,2	143	FC700 RP	4T-4703 RP	70													
						100,2	220	FC800 RP	6I-8803	80													

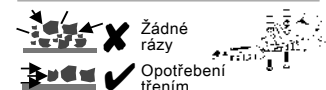

## ZUBY PRO NAKLADAČE / RÝPADLA TYP CATERPILLAR

**RC**  
Skalní dláto

Kg	Lb	Part#	OEM	Size
2,7	6	FC200 RC	-	20
4,2	9	FC250 RC	-	25
5,9	13	FC300 RC	1U-3302 RC 125-8309	30
8,8	19	FC350 RC	1U-3352 RC 119-9359	35
11,6	26	FC400 RC	7T-3402 RC 124-7409	40
17,7	39	FC450 RC	1U-3452 RC 116-7459	45
30,5	67	FC550 RC	1U-3552 RC 113-0559	55
40,6	89	FC600 RC	6I-6602 RC 119-9609	60
57,2	126	FC700 RC	4T-4702 RC	70
84,7	186	FC800 RC	-	80

**RE**  
Skalní penetrační

Kg	Lb	Part#	OEM	Size
5,6	12	FC300 RE	1U-3302 RC 125-8309	30
8,3	18	FC350 RE	1U-3352 RC 119-9359	35
10,9	24	FC400 RE	7T-3402 RC 124-7409	40
15,8	35	FC450 RE	1U-3452 RC 116-7459	45
28,1	62	FC550 RE	1U-3552 RC 113-0559	55
40,5	89	FC600 RE	6I-6602 RC 119-9609	60
55,5	122	FC700 RE	4T-4702 RC	70

**P**  
Penetrační

Kg	Lb	Part#	OEM	Size
1,4	3	FC200 P	1U-3209	20
3,2	7	FC250 P	9J-4259	25
4,5	10	FC300 P	9J-4309	30
6,5	14	FC350 P	9J-4359	35
9,7	21	FC400 P	6Y-7409	40
13,1	29	FC450 P	9W-8459	45
17,9	39	FC550 P	9W-8559	55
27,3	60	FC600 P	7I-7609	60
37,4	82	FC700 P	4T-4709	70
54,8	121	FC800 P	117-6809	80

**PHC**  
Penetrační s tvrdým jádrem

Kg	Lb	Part#	OEM	Size
13,2	29	FC450 PHC	9W-8459	45

Zub PHC jehož předností je tvrdokovové jádro pro extrémní pronikavost

**EXTRÉMNI PRONIKAVOST**

700HB

**WTL**  
Dvojšpičatý dlouhý

Kg	Lb	Part#	OEM	Size
1,8	4	FC200 WTL	1U-3202 WTL 135-8208	20
4,0	9	FC250 WTL	1U-3252 WTL 135-8258	25
5,6	12	FC300 WTL	1U-3302 WTL 135-9308	30
8,5	19	FC350 WTL	1U-3352 WTL 135-9337	35
14,0	31	FC400 WTL	7T-3402 WTL 135-9408	40
16,1	35	FC450 WTL	1U-3452 WTL 138-6458	45
22,6	50	FC550 WTL	1U-3552 WTL 138-6558	55
39,9	88	FC600 WTL	6I-6602 WTL 135-9608	60
54,2	119	FC700 WTL	4T-4702 WTL	70

**TL**  
Špičatý

Kg	Lb	Part#	OEM	Size
1,2	3	FC200 TL	1U-3202 TL 9W-8209	20
2,6	6	FC250 TL	1U-3252 TL 9W-8259	25
3,7	8	FC300 TL	1U-3302 TL 9W-8309	30
6,2	14	FC350 TL	1U-3352 TL 9W-2359	35
10,3	23	FC400 TL	7T-3402 TL 9W-5409	40
12,8	28	FC450 TL	1U-3452 TL 7I-8459	45
17,5	39	FC550 TL	1U-3552 TL 9W-6559	55
31,0	68	FC600 TL	6I-6602 TL 107-8609	60
44,0	97	FC700 TL	4T-4702 TL	70

**WTS**  
Dvojšpičatý ostrý

Kg	Lb	Part#	OEM	Size
8,0	18	FC350 WTS		35
15,6	34	FC450 WTS		45

**I**  
Rázuvzdorný

Kg	Lb	Part#	OEM	Size
5,2	11	FC300 I	1U-3301	30
7,1	16	FC350 I	1U-3351	35
14,4	32	FC450 I	9W-8451 / 1U-3451	45
21,8	48	FC550 I	9W-8551 / 1U-3551	55

**U**

**DRP CATERPILLAR UNIVERZÁLNÍ ZUBY (MONTÁŽ KLADIVEM)**

Kg	Lb	Part#	OEM	Size
4,97	11	FC2-300 U	1U-3302	30
7,49	16	FC2-350 U	1U-3352	35
12,63	28	FC2-450 U	9W-8452	45



**U**

Kg	Lb	Part#	OEM	Size
3,20	7	FC250 U	1U-3252	25
3,90	9	FC300 U	1U-3302	30
6,00	13	FC350 U	1U-3352	35
10,70	24	FC450 U	9W-8452	45

**L**

Kg	Lb	Part#	OEM	Size
4,50	10	FC2-300 L	1U-3302	30
6,50	14	FC2-350 L	1U-3352	35
11,80	26	FC2-450 L	9W-8452	45

**HL2P**

Kg	Lb	Part#	OEM	Size
8,0	17	FC2-300	3G-6304	30
10,1	22	FC2-350	6I-6354	35
20,6	45	FC2-450	6I-6464	45

**HL2P**

Kg	Lb	Part#	Size
0,2	0,4	FC300HL2P	30
0,3	0,7	FC350HL2P	35
0,5	1,2	FC450HL2P	45

- JEDEN ZUB POUŽITELNÝ PRO DVA SYSTÉMY**  
Zuby FUTURA II jsou plně kompatibilní se standardními adaptéry řady J
- SYSTÉM BEZ POUŽITÍ KLADIVA**
- VYNIKAJÍCÍ KVALITA A BEZKONKURENČNÍ CENA**

## ADAPTERY TYPU CATERPILLAR

Kg	Lb	B°		Part#	OEM	F Size
20,0	44	22°		<b>FC400 S</b>	125-8404	1
19,6	43	22°	45	1,8"	<b>FC400 S RHS</b>	1
19,6	43	22°		<b>FC400 S LHS</b>	-	1
23,5	52	22°		<b>FC450 S</b>	114-0464	1
24,1	53	22°	50	2"	<b>FC450 S RHS</b>	1
24,1	53	22°		<b>FC450 S LHS</b>	114-0465	1
43,5	96	22°		<b>FC550 S</b>	107-3554	2
44,3	97	22°	60	2,4"	<b>FC550 S RHS</b>	2
44,3	97	22°	63	2,9"	<b>FC550 S LHS</b>	2
77,0	169	22°		<b>FC600 S</b>	119-8604	2
78,2	172	22°	70	2,8"	<b>FC600 S RHS</b>	2
78,2	172	22°		<b>FC600 S LHS</b>	119-8606	2
77,8	171	22°		<b>FC700 S</b>	133-0704	2
78,7	173	22°	70	2,8"	<b>FC700 S RHS</b>	2
80,4	177	22°	75	3"	<b>FC700 S LHS</b>	2
123,7	272	22°	100	3,9"	<b>FC800 S</b>	2

S

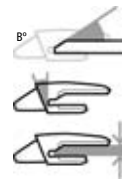

Poz. 1 Standard



Poz 2 S krytem

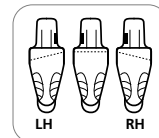

Kg	Lb	Part#	Size
8,3	18	<b>FC550 SWCU</b>	55
14,2	31	<b>FC600 SWCU</b>	60
12,0	26	<b>FC700 SWCU</b>	70
22,8	50	<b>FC800 SWCU</b>	80



SWCD

Kg	Lb	Part#	Size
5,1	11	<b>FC550 SWCD</b>	55
11,8	26	<b>FC600 SWCD</b>	60
10,4	23	<b>FC700 SWCD</b>	70
17,0	37	<b>FC800 SWCD</b>	80

## ADAPTERY TYPU CATERPILLAR

Kg	Lb	B°		Part#	RH	LH	RHS	LHS	OEM	F Size
1,8	4	22°	20	0,8"	<b>FC200</b>				119-32051	20
3,3	7	22°	20	0,8"	<b>FC220</b>				6Y-3224	22
4,4	10	22°	25	1"	<b>FC250-25</b>				6Y-3254	25
4,4	10	22°	30	1,2"	<b>FC250</b>				113-3253	1
7,5	16	22°	30	1,2"	<b>FC300</b>				3G-6304	30
7,6	17	22°	35	1,4"	<b>FC300-35</b>				8E-9490	1
10,5	23	22°	40	1,6"	<b>FC350</b>				6I-6354	1
10,2	22	35°	35	1,4"	<b>FC350-B35</b>				3G-8354	1
14,4	32	22°	45	1,8"	<b>FC400</b>				6I-6404	1
22,2	49	22°	50	2"	<b>FC450</b>	✓	✓	✓	6I-6464	1
34,0	75	22°	63	2,4"	<b>FC450-63</b>	✓	✓	✓		1
35,1	77	22°	60	2,4"	<b>FC550</b>	✓	✓	✓	6I-6554	1
65,6	144	22°	70	2,8"	<b>FC600</b>	✓	✓	✓	6I-6604	1
64,4	142	22°	80	3,1"	<b>FC600-80</b>	✓	✓	✓		1
87,3	192	35°	90	3,5"	<b>FC700</b>	✓	✓	✓	222-7700	1
87,1	192	35°	95	3,7"	<b>FC700-95</b>	✓	✓	✓		2
122,0	268	30°	100	3,9"	<b>FC800</b>	✓	✓	✓	6I-8804	2

X

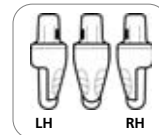

Poz. 1 Standard



Poz. 2 S krytom

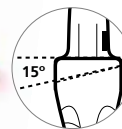
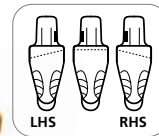

## NAVAŘOVACÍ NOSY

WN



Kg	Lb	Part#	Size
1,0	2	<b>WN-200</b>	20
1,8	4	<b>WN-220</b>	22
2,4	5	<b>WN-250</b>	25
4,3	9	<b>WN-300</b>	30
5,0	11	<b>WN-350</b>	35
7,0	15	<b>WN-400</b>	40
9,2	20	<b>WN-450</b>	45
13,5	30	<b>WN-550</b>	55
26,0	57	<b>WN-600</b>	60
31,2	69	<b>WN-700</b>	70
44,3	97	<b>WN-800</b>	80



Kryty  
adapterů



WC  
500HB

Kg	Lb	Part#	Size
4,7	10	<b>FC550 WC</b>	55
8,1	18	<b>FC600 WC</b>	60
10,2	22	<b>FC700 WC</b>	70
15,9	35	<b>FC800 WC</b>	80



WC7  
700HB

Kg	Lb	Part#	Size
4,7	10	<b>FC550 WC7</b>	55
7,9	17	<b>FC600 WC7</b>	60
9,9	22	<b>FC700 WC7</b>	70
15,0	33	<b>FC800 WC7</b>	80

## ZUBY TYP CATERPILLAR

L Dlouhý

Kg	Lb	Part#	OEM
1,4	3	<b>FC23 L</b>	4K-6936
1,9	4	<b>FC34 L</b>	4K-0034



F Shora vařené adaptory



Kg	Lb	B°		Part#	
3,5	8	25°	13-20	0,5-0,8"	<b>FC23 F</b>

R Adaptory pro rýpadla



Kg	Lb	B°		Part#	
2,7	6	25°	13-20	0,5-0,8"	<b>FC23 R</b>

P Penetrační

Kg	Lb	Part#	OEM
1,1	2	<b>FC23 P</b>	4K-6936

## RŮZNÉ ZÁMĚNNÉ DÍLY TYPU CATERPILLAR

### ZUBY VIDLICOVÉ

6Y



Kg	Lb	Part#	OEM	
3,6	8	19	0,7"	<b>FC6Y-6335</b>

### OCHRANA BŘITU

109

Kg	Lb	Part#	OEM		
52	115	<b>FC109-9080</b>	109-9080 988		
54	118	45	1,8"	<b>FC109-9081</b>	109-9081 988F
54	118	<b>FC109-9082</b>	109-9082 988G		
155	341	<b>FC109-9030</b>	109-9030		
155	341	100	3,9"	<b>FC109-9031</b>	109-9031 994
155	341	<b>FC109-9032</b>	109-9032		



### ROZRÝVAČE A ZUBY

Tělo rozrývače

Kg	Lb	Part#	OEM
5,4	12	<b>FC10 SS</b>	9F-5124

Zub rozrývače

Kg	Lb	Part#	OEM
1,5	3	<b>FC10 TS</b>	6Y-5230 2D-5572

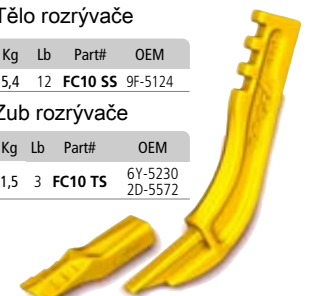

## MINIRÝPADLA

**17-7**

Zuby pro minirýpadla

Kg	Lb	↓	Part#	OEM
1,3	3	16	F17-7	2130/76

**L**

Zuby pro minirýpadla

Kg	Lb	Part#
0,7	2	FE15 L

**R**

Adaptéry k navaření

Kg	Lb	B°	↓	Part#	
1,0	2	24°	16	0,8"	FE15 R

**S**

Standardní

Kg	Lb	Part#	OEM	Size
2,4	5	FE25 S	255	25
2,9	6	FE30 S	305	30
4,2	9	FE35 S	355	35
6,9	15	FE40 S	405	40

## ZUBY TYP ESCO

**L**

Dlouhý

Kg	Lb	Part#	OEM	Size
1,1	2	FE18 L	18TL	18

**P**

Penetrační

Kg	Lb	Part#	OEM	Size
1,1	2	FE18 P	18VIP	18

**TVC**

Dvou špička

Kg	Lb	Part#	OEM	Size
1,4	3	FE18 TVC	18WTL	18

**R**

Adaptéry k navaření

Kg	Lb	B°	↓	Part#	OEM	Size
1,6	4	28	20	0,8"	FE18 R	833-18 18
3,7	8	23	25	1,0"	FE25 R	855-25 25

## ZUBY TYP FIAT HITACHI

**S**

Standardní

Kg	Lb	Part#	OEM	Size
3,5	8	FF22 S	72185129 / FM22S	22
7,0	15	FF24 S	72185132 / FM24S	24
10,6	23	FF26 S	72185134 / FM26S	26
16,0	35	FF28 S	71468101 / FM28S	28
24,2	53	FF32 S	FM32S	32

**RC**

Skalní dláto

Kg	Lb	Part#	OEM	Size
3,8	8	FF22 RC	MF22E	22
6,6	15	FF24 RC	72185133 / MF24E	24
10,2	22	FF26 RC	72185135 / MF26E	26
15,3	34	FF28 RC	72185121 / MF28E	28

## ZUBY TYP KOMATSU

**I**

Rázuvzdorný

Kg	Lb	Part#	OEM	Size
5,6	12	FK200 I		200
8,6	19	FK300 I	20Y-70-K4070	300
12,0	26	FK400 I		400

**S**

Standardní

Kg	Lb	Part#	OEM	Size
5,1	11	FK200 S	205-70-19570	200
7,9	17	FK300 S	207-70-14151	300
11,6	26	FK400 S	208-70-14152	400

**TL**

Špičatý dlouhý

Kg	Lb	Part#	OEM	Size
5,3	12	FK200 TL	20Y-70-K4060	200
7,7	17	FK300 TL	20Y-70-K4070	300
11,4	25	FK400 TL	208-70-K1340	400

**RPL**

Skalní penetrační lehký

Kg	Lb	Part#	OEM	Size
		FK420 RPL	423-847-1140	420
12,0	26	FK600 RPL	426-847-1110	600

**RC**

Symetrický

Kg	Lb	Part#	OEM	Size
7,0	15	FK200 RC	205-70-19570	200
10,3	23	FK300 RC	207-70-14151	300
15,5	34	FK400 RC	208-70-14152	400
35,1	77	FK750 RC	208-70-14152 209-70-54720	650 750
54,8	121	FK1100 RC	209-70-54720 21N-72-14290	1000 1100

**R2** Ryprový zub střední

Kg	Lb	Part#	OEM	Size
16,8	37	FK155 R2	175-78-31230 175-78-31232	155
21,0	46	FK355 R2	195-78-21331 195-78-21333	355
30,9	68	FK375 R2	195-78-71320 195-78-71330	375
38,2	84	FK475 R2	198-78-21420 198-78-21380	475



# FUTURA CLACK SYSTEM 100% kompatibilní s Vašimi aktuálními Caterpillar rozrývači

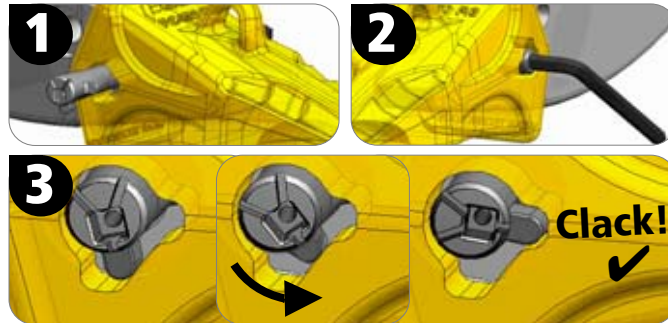

## SYSTEM BEZ POUŽITÍ KLADIVA

L	in	o	inch	Kg	Lb	Part#	Size
92	3,6	20,5	0,8	0,3	0,6	FCR300HP	R300
120	4,7	20,5	0,8	0,4	0,8	FCR350HP	R350
135	5,3	26,0	1,0	0,7	1,5	FCR450HP	R450
153	6,0	33,0	1,3	1,2	2,7	FCR500HP	R500
170	6,7	37,5	1,5	1,7	3,8	FCR550HP	R550

Nový systém je 100% kompatibilní s Vašimi současnými rozrývači typu Cat ✓ **Zvýšená retence pojistky:** čepy jsou pevně uzamčeny v místě. Gumová vložka pod zámkem umožňuje západce (obr. 3) stlačení, otočení a uzamčení ✓ **Snadná instalace a vyjmutí** klíčkou nebo ráčnou se šestihranem.

Každá pojistka je dodávána se zesíleným krytem pro udržení zásuvky v čistotě ✓ **VŠECHNY** FUTURA Clack zuby mohou být použity s novým FUTURA systémem bez použití kladiva stejně jako standardními Caterpillar čepy a kroužky ✓

### R1

Krátký



Kg	Lb	Part#	OEM	Size
19,3	42	FC450 R1	9W-2451 4T-5451	R450
32,0	70	FC500 R1	4T-4501 4T-5501	R500
51,1	112	FC550 R1	9W-4551	R550

### R2

Střední



Kg	Lb	Part#	OEM	Size
6,3	14	FC300 R2	4T-4302 6Y-0309	R300
14,6	32	FC350 R2	6Y-0352 6Y-0359	R350
20,8	46	FC450 R2	9W-2452 4T-5452	R450
30,0	66	FC500 R2	4T-5502	R500
55,4	122	FC550 R2	6Y-3552	R550

### RPT



Kg	Lb	Part#	OEM
50,5	111	75 3,0"	6J-8814 132-4716
105,8	233	90 3,5"	9W-8365 132-1014
108,6	239	100 3,9"	6Y-8960 132-1015
146,5	322	110 4,3"	9N-4621 132-1016

### R2ST

Střední zeštíhlený



Kg	Lb	Part#	OEM	Size
14,3	31	FC350 R2ST	6Y-0352ST	R350
19,8	44	FC450 R2ST	9W2452ST	R450
32,7	72	FC500 R2ST	4T-5502ST	R500

### R2S

Střední symetrický



Kg	Lb	Part#	OEM	Size
36,3	80	FC500 R2S	4T-4502	R500
57,0	125	FC550 R2S	9W-4552	R550

### R3

Dlouhý



Kg	Lb	Part#	OEM	Size
22,9	50	FC450 R3	114-0453	R450
37,9	83	FC500 R3	4T-5503 4T-4503	R500

### R3ST

Střední zeštíhlený



Kg	Lb	Part#	OEM	Size
36,6	81	FC500 R3ST	4T-5503 4T-4503	R500

**NOVÝ KRYT RYPRU PRO MONTÁŽ BEZ KLADIVA. VYLEPŠENÝ TVAR PRO EXTRA OCHRANU TĚLA RYPRU A KORUNKY**

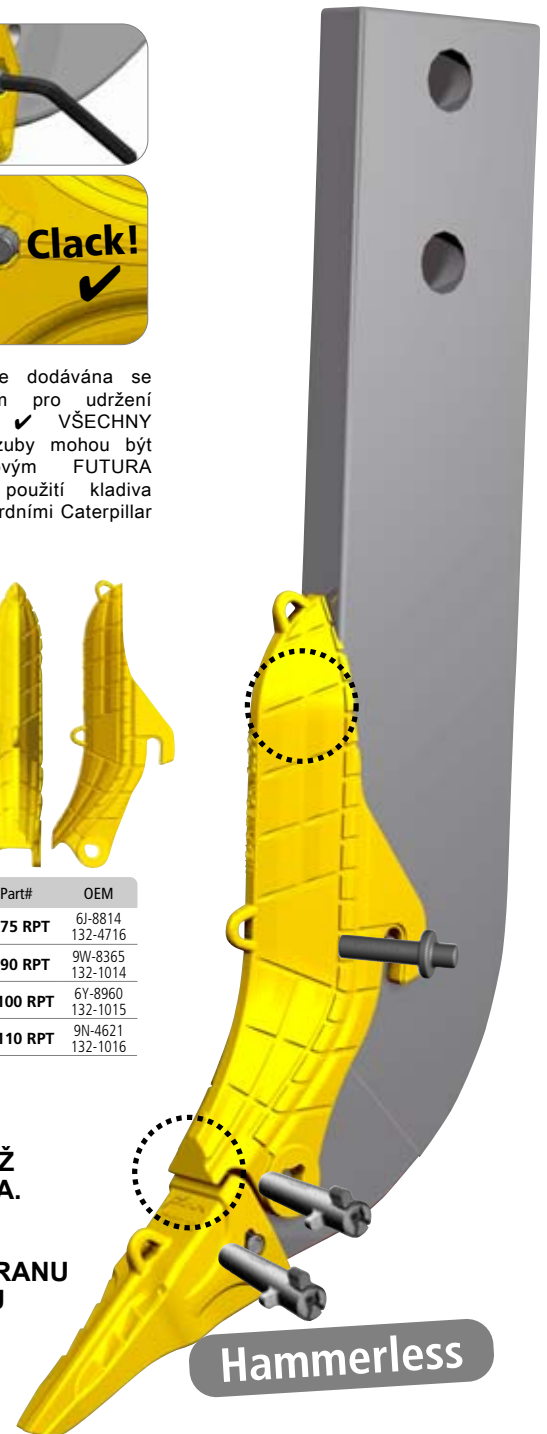

**VYMĚNITELNÝ HROT KORUNKY RYPRU BEZ POUŽITÍ KLADIVA**



Kg	Lb	Part#	Size
12,4	27	FC500 TXR2	R500

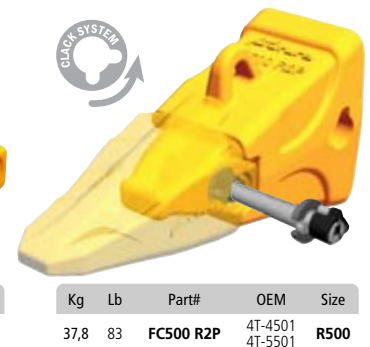

Kg	Lb	Part#	OEM	Size
37,8	83	FC500 R2P	4T-4501 4T-5501	R500

### OCHRANY K NAVÁŘENÍ

PTV

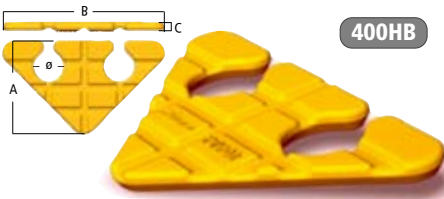

400HB

A	B	C	Ø	Kg.	Lb	Part#			
158	6,2"	275	10,8"	16	0,6"	50 2,0"	2,0	4	PTV-01

FUTURA otěruvzdorná kolečka a tyče jsou vyráběny s o 20% více otěruvzdorným materiálem oproti standardním výrobkům ✓

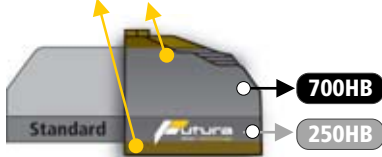

700HB

250HB

# Ochrana lžíce



### ROLL BAR 700HB

RB

700HB

NOVÝ

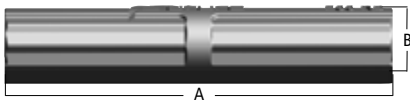
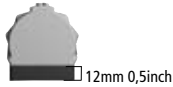

A	B	Ø	Kg.	Lb	Part#	Cross Ref			
229	9"	28	1,1"	35	1,4"	1,9	4	F35 RB	280-4096
305	12"	42	1,7"	55	2,2"	5,7	12	F55 RB	280-4097
305	12"	59	2,3"	80	3,1"	10,8	24	F80 RB	280-4098

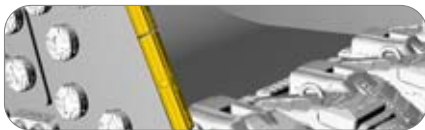

### CHOCKY BARS 700HB

CB

700HB

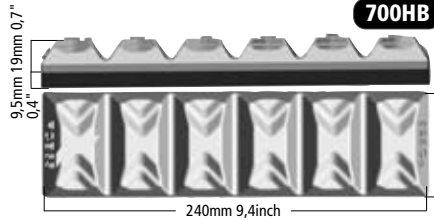

B	Kg.	Lb	Part#	Cross Ref
25	1,0"	1,0	2	F25 CB D25CB
40	1,6"	1,6	4	F40 CB D38CB, CB40N, 1086NA
50	2,0"	2,1	5	F50 CB D51CB, CB50N
65	2,6"	2,8	6	F65 CB D64CB, CB65N, 1088NA
100	3,9"	4,3	9	F100 CB D100CB, CB100N
150	5,9"	5,7	13	F130 CB D130CB, CB130N, 090NA



### WEAR BUTTONS 700HB

WB

700HB

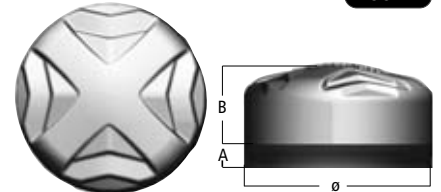

A	B	Ø	Kg.	Lb	Part#	Cross Ref			
9,5	0,4"	21	0,8"	60	2,4"	0,6	1	F60 WB	D50BN WB60
9,5	0,4"	28	1,1"	75	3,0"	1,1	2	F75 WB	D75BN WB75
9,5	0,4"	34	1,3"	90	3,5"	1,4	3	F90 WB	D90BN WB90
13	0,5"	35	1,4"	115	4,5"	3,3	7	F115 WB	D114BN D150BN
16	0,6"	45	1,8"	150	5,9"	7,2	16	F150 WB	WB150



### BOČNÍ ŘEZÁKY K NAVÁŘENÍ 450 HB

WS

450HB



mm	inch	A	B	Kg.	Lb	Part#	Cross Ref	
150	5,9"	32	1,3"	1,6	4	F150 WS	14,5 16 0,6"	
200	7,9"	40	1,6"	3,4	7	F200 WS	20 0,8"	
280	11,0"	40	1,6"	5,0	11	F280 WS	28 1,1"	WP725

### BOČNÍ ŘEZÁKY VÝMĚNNÉ 500 HB

SC

500HB



mm	inch	A	B	Kg.	Lb	Part#	Cross Ref	
483	19,0"	106	4,2"	28,3	62	F3050 SC	30 1,2" 50 2"	TAW38X440 TAW40X440 TAW50X505
603	23,7"	373	14,7"	58,7	129	F6080 SC	60 2,4" 80 3,1"	TBW75X545 TBW75X655

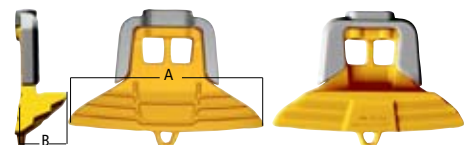
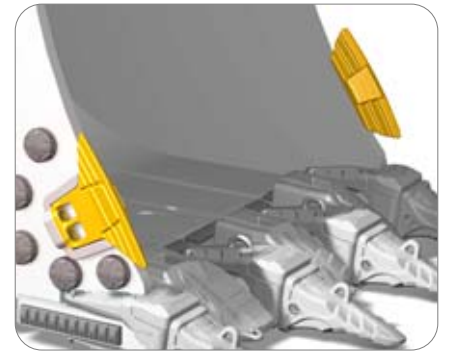

### KRYT BOKŮ K NAVĚŘENÍ

HS  
450HB



Kg.	Lb.	Part#	Cross Ref
9,6	21	<b>F10 HS</b>	ES6697-4 ES6697-4HX
11,9	26	<b>F12 HS</b>	ES6697-3 ES6697-3HX
23,2	51	<b>F24 HS</b>	ES6697-2 ES6697-2HX
40,6	89	<b>F40 HS</b>	ES6697-5 ES6697-5HX
87,9	193	<b>F90 HS</b>	ES6697-7

### KRYTÍ BOKŮ VÝMĚNNÉ

HSQR  
500HB

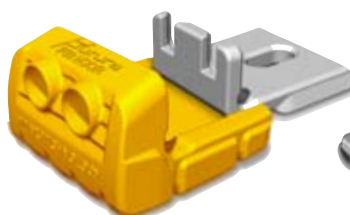

Kg.	Lb.	Part#	Cross Ref
19,5	43	<b>F49 HSQR</b>	ES6697-4 ES6697-4HX
21,6	47	<b>F59 HSQR</b>	ES6697-3 ES6697-3HX
40,3	89	<b>F69 HSQR</b>	ES6697-2 ES6697-2HX
62,2	137	<b>F89 HSQR</b>	ES6697-5 ES6697-5HX

### OTĚRUVZDORNÉ BĚHOVNÝ VÝMĚNNÉ

WR  
500HB



Kg.	Lb.	Part#	Cross Ref
9,9	22	<b>F39 WR</b>	KLR01MC
12,2	27	<b>F49 WR</b>	KLR02MC B8X8WR175
22,9	50	<b>F59 WR</b>	KLR01MB
31,1	68	<b>F79 WR</b>	LRO2MB B10X10WR27

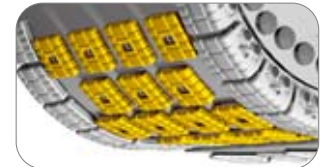
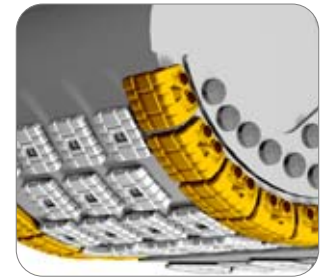

### KRYTÍ BŘÍTU K NAVĚŘENÍ 450 HB

LS  
450HB



α	Kg.	Lb.	Part#	↓ ↑	Size
	6,2	14	<b>F50 LS</b>		
22	7,0	15	<b>F50 LSRH</b>	40	1,6" 460
	7,0	15	<b>F50 LSLH</b>	50	2" 460
	19,3	42	<b>F60 LS</b>		
22	20,0	44	<b>F60 LSRH</b>	60	2,4" 550
	20,0	44	<b>F60 LSLH</b>		
	21,0	46	<b>F70 LS</b>		
22	21,9	48	<b>F70 LSRH</b>	70	2,8" 600
	21,9	48	<b>F70 LSLH</b>	75	3" 600
	35,7	79	<b>F90 LS</b>		
35	36,7	81	<b>F90 LSRH</b>	80	3,1" 700
	36,7	81	<b>F90 LSLH</b>	100	3,9" 700

### KRYTÍ BŘÍTU VÝMĚNNÉ 500 HB

LSQR  
500HB



α	Kg.	Lb.	Part#	↓ ↑	Size
	13,3	29	<b>F50 LSQR</b>		
22	14,1	31	<b>F50 LSQR RH</b>	50	2" 460
	14,3	31	<b>F50 LSQR LH</b>		
	37,6	83	<b>F60 LSQR</b>		
22	41,2	91	<b>F60 LSQR RH</b>	60	2,4" 550
	41,7	92	<b>F60 LSQR LH</b>		
	40,7	90	<b>F70 LSQR</b>		
22	43,3	95	<b>F70 LSQR RH</b>	70	2,8" 600
	43,3	95	<b>F70 LSQR LH</b>	75	3" 600
	70,6	155	<b>F90 LSQR</b>		
35	73,8	162	<b>F90 LSQR RH</b>	90	3,5" 700
	73,8	162	<b>F90 LSQR LH</b>		
	97,2	214	<b>F100 LSQR</b>		
30	105,7	233	<b>F100 LSQR RH</b>	100	3,9" 700
	104,2	229	<b>F100 LSQR LH</b>		
	98,0	216	<b>F120 LSQR</b>		
30	102,0	224	<b>F120 LSQR RH</b>	120	4,7" 800
	102,0	224	<b>F120 LSQR LH</b>		



## OCHRANA LŽIC: KRÁTKÝ PRŮVODCE

mm	in	22°	30°		
15-22 TON	30 35	1,2" 1,4"	FC300 FC300-35	FT290 FT290-35	F10 HS F150 WS
20-25 TN	40 45	1,6" 1,8"	FC350 FC400	FT290-40 FT330 FT390	F39 WR F49 HSQR F12 HS F200 WS
24-40 TN	50	2,0"	FC450	FT430	F49 WR F49 HSQR F24 HS F280 WS F3050 SC
40-53 TN	60	2,4"	FC550	FT510	F49 WR F59 HSQR F24 HS F280 WS F3050 SC
53-68 TN	70 75	2,8" 3"	FC600	FT590	F59 WR F59 HSQR F24 HS F6080 SC
70- 119 TN	80 90 95	3,1" 3,5" 3,7"	FC600-80 FC700 FC700-95	FT610 FT690 FT690-90 FT710	F60 WB F75 WB F90 WB F115 WB F150 WB F25 CB F40 CB F50 CB F65 CB F100 CB F130 CB F35 RB F55 RB F80 RB PTV-01
150 TN	100	3,9"	FC800	FT710-100	F59 WR F59 HSQR F24 HS F6080 SC
180- 200 TN	120	4,7"	F120 LSQR	FT810	F59 WR F69 HSQR F40 HS
250 TN	140	5,5"		FT810-140 FM950	F79 WR F69 HSQR F40 HS
350 TN	160	6,3"		FM950 FM1100	F79 WR F89 HSQR F40 HS
500 TN	230	9"		FM-1300	F90 HS



Poradenství, servis a prodej  
v České a Slovenské republice:

**RENOMAG spol. s r.o.**  
Cukrovarská 1266, Rosice  
664 84 Zastávka u Brna  
Česká republika

Tel.: +420 546 411 678  
Fax: +420 546 411 679  
E-mail: [renomag@renomag.cz](mailto:renomag@renomag.cz)  
Web: <http://www.renomag.cz>

**RENOMAG SLOVAKIA s.r.o.**  
Kopčianska 63  
851 01 Bratislava  
Slovenská republika  
Tel.: +421 911 401 402  
E-mail: [info@renomagslovakia.sk](mailto:info@renomagslovakia.sk)  
Web: <http://www.renomag.sk>



# renomag